



Contenido hoja: **ESPIGAS CON SOPORTE**

Hoja num. : 62

ESCALA DIBUJOS: 1/1

MATERIAL: Latón

DIMENSIONES: L x H x A (En décimas de mm.)

L = Longitud total

H = Altura pestaña espiga

A = Anchura base soporte



28002

CIERRE SEGURIDAD
(opcional)

**TODOS LOS MODELOS TIENEN OPCION
DE LLEVAR CIERRE DE SEGURIDAD**

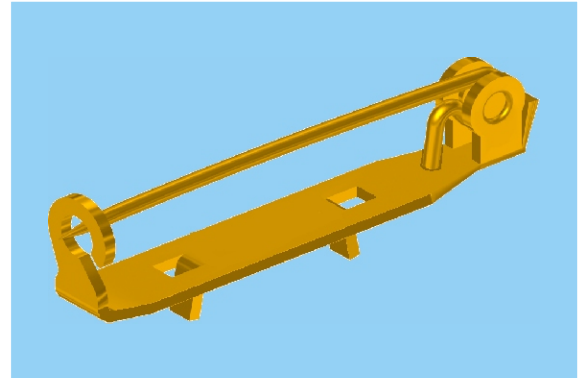

SOPORTE LISO :



49017
170 x 47 x 30
largo 17 mm.

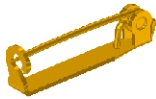

49021
210 x 47 x 30
largo 21 mm.

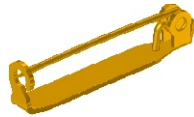

49026
260 x 47 x 40
largo 26 mm.

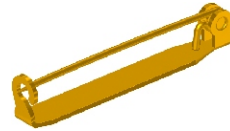

49031
310 x 47 x 40
largo 31 mm.

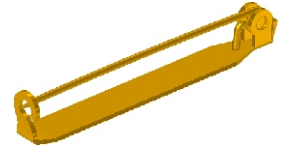

49036
365 x 47 x 45
largo 36 mm.

SOPORTE CON CALADOS :



49018
170 x 47 x 30 / C
largo 17 mm.

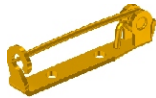

49022
210 x 47 x 30 / C
largo 21 mm.

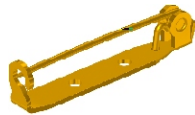

49027
260 x 47 x 40 / C
largo 26 mm.

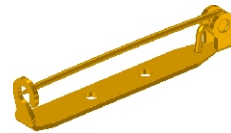

49032
310 x 47 x 40 / C
largo 31 mm.

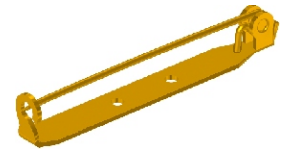

49037
365 x 47 x 45 / C
largo 36 mm.

SOPORTE CON PATAS :



49019
170 x 47 x 30 / P
largo 17 mm.



49023
210 x 47 x 30 / P
largo 21 mm.

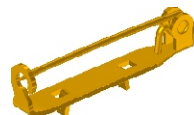

49028
260 x 47 x 40 / P
largo 26 mm.

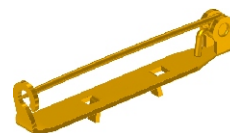

49033
310 x 47 x 40 / P
largo 31 mm.

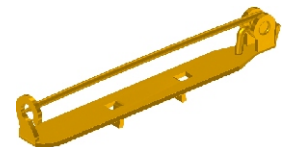

49038
365 x 47 x 45 / P
largo 36 mm.

SOPORTES :



49084
De 17



49085
De 17/C



49090
De 2 1/2 C



49086
De 26

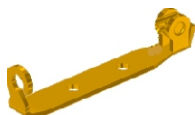

49091
De 26/C



49087
De 31

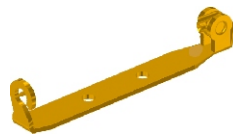

49088
De 31/C

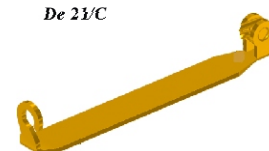

49035
De 36

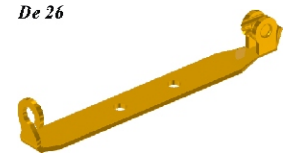

49034
De 36/C